

**Smart Remote Terminal Units (RTUs)  
for RMU & Panel Switchgear Automation**

# Callisto NX Smart RTU and Software Range

Callisto NX is a modular RTU solution with software tools for use in automation projects.



### Callisto NX plug-in modules

- PSU or battery charger
- DI/DO configurations
- Analogue AC/DC
- Communications



For supply to DNOs, IDNOs, TSOs, systems integrators and switchgear companies in applications from Generation and Transmission to Distribution and LV supplies.





**Celeste<sup>nx</sup>**  
energy edition

Master Station Software Suite



**CaSE<sup>nx</sup>**

User Friendly Callisto<sup>nx</sup> Software Editor



**PILOT<sup>nx</sup>**

Programmable Integrated Logic Tool



**VIEW<sup>nx</sup>**

Embedded Web Server



**Touch<sup>nx</sup>**

Touch screen colour graphics LUI

The image shows a satellite network visualization over Earth. A network of white nodes and thin white lines is overlaid on the planet's surface. A prominent, thick, glowing blue line runs diagonally across the image, representing a specific data path or network backbone. The background is a view of Earth from space, showing the curvature of the planet and the dark void of space.

**Over 50,000 Callisto RTUs installed worldwide**

**Over 25,000 in the UK**



- Power generation, transmission and distribution
- **RMU automation**
- Pole top applications
- Solar PV and wind farms
- LV monitoring and control

# UK Manufactured Callisto RMU Solutions

11kV RMU RTU  
(1-4 Switch)



11kV RMU RTU  
(3 Switch)



11kV RMU/OH  
(1-6 Switches)



Callisto NX RTUs in custom cabinet solutions.  
Made by Remsdag at our Deeside, North Wales manufacturing facility.



Product also available to  
System integrators

## Cyber secure solutions for new and retrofit substations

- Mains or DC powered (option)
- Intelligent Battery Charger (SLA / Lithium)
- Solutions for any number of switches or CBs including panel switchgear
- Open Protocols support - IEC 61850, DNP3, IEC 60870-5-101/103/104 and Modbus
- Internal or External Fault Passage Indication
- RTUs with prewired plant connectors or wiring to internal DIN rail terminals
- Touch screen HMI / Traditional Local / Remote switch panel
- IEC 61131-3 Logic for automation / pre-programmed intelligence.
- Metering options
- Power Quality and COMTRADE fault records
- Data concentration from third party IEDs
- Compatible with IP and Serial Communications equipment
- Custom solutions upon request

# Callisto NX Automation Applications

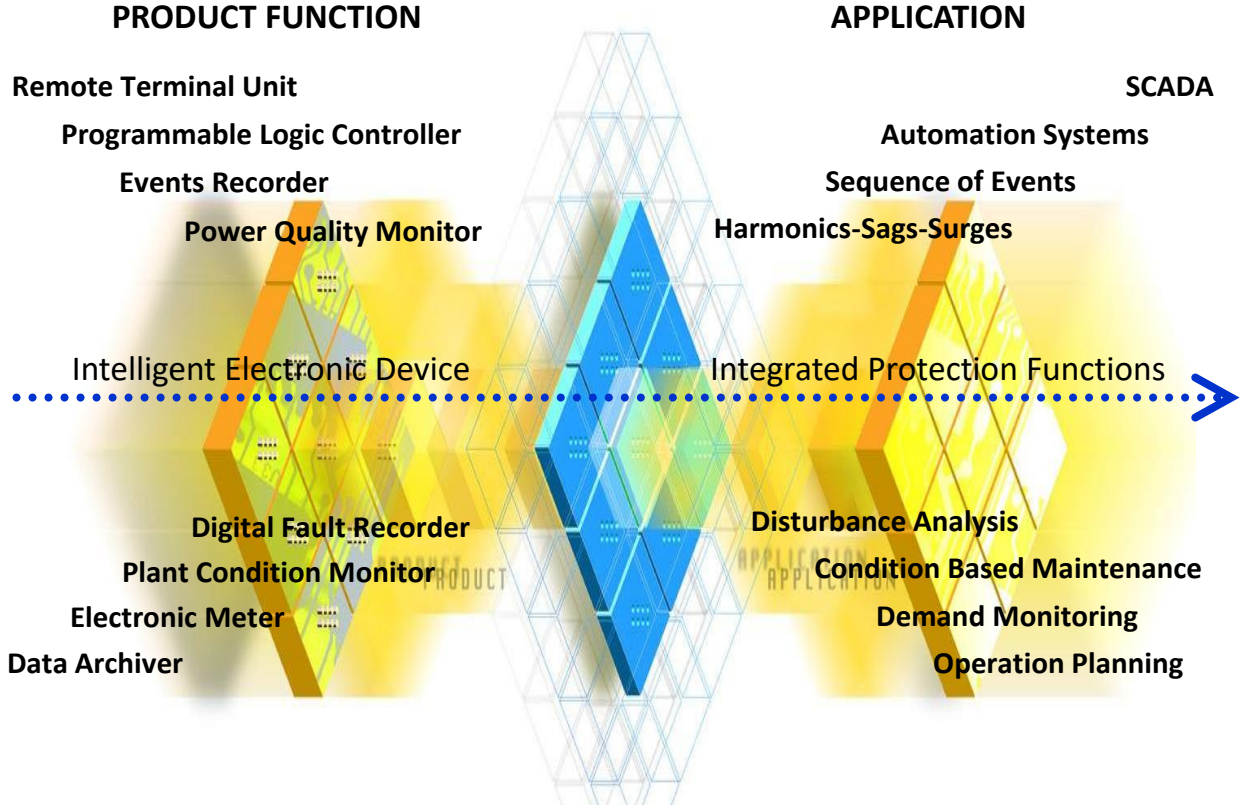

Remsdaq Technical Objective: to deliver a single product fulfilling multiple applications.







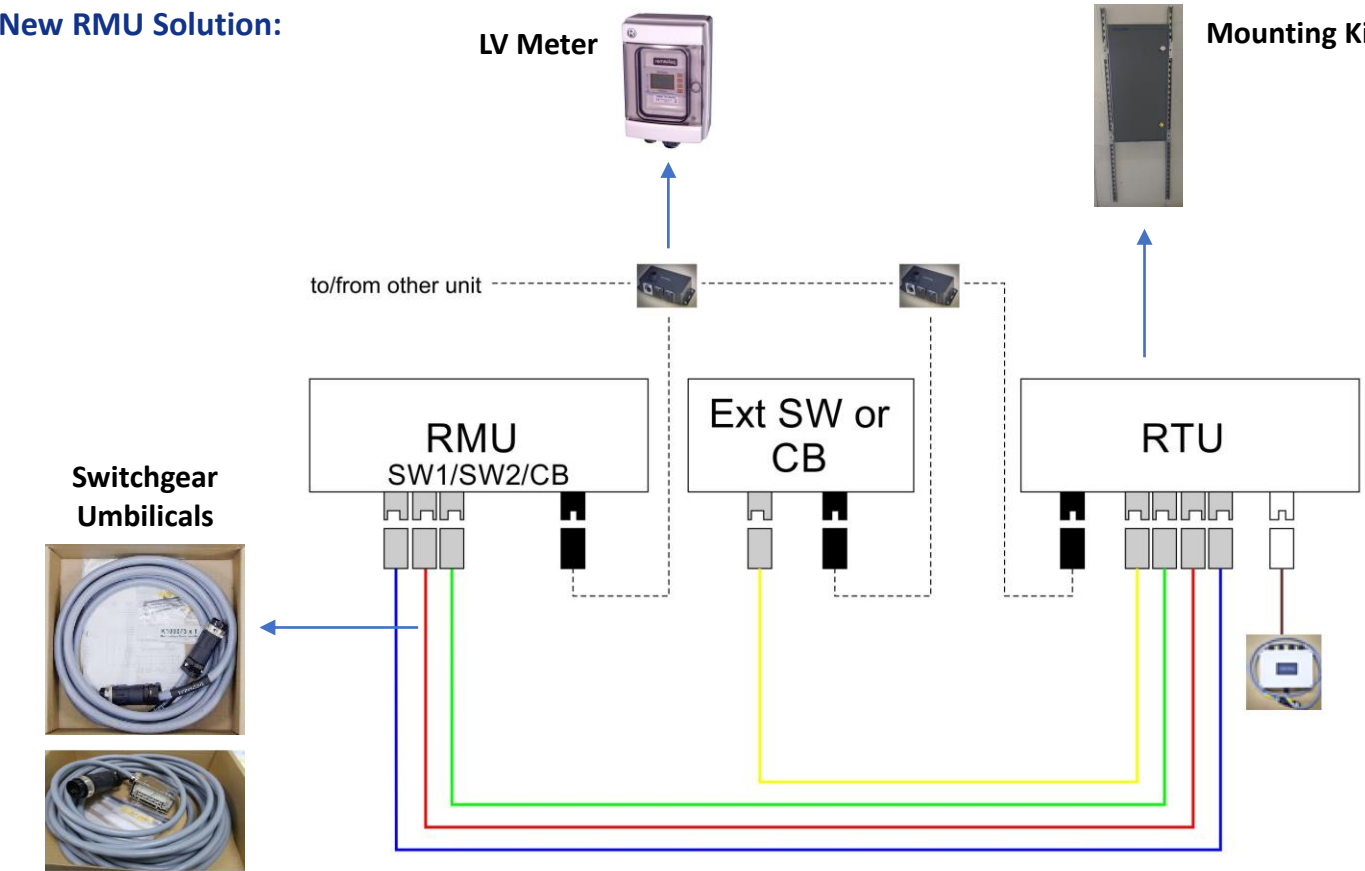







# New Substation RMU Solution:

## New RMU Solution:



## Mounting Kits Wall/Free Standing



KEY	
	Umbilical Plug
	RJ45 Plug
	Auxiliary Umbilical Plug
	Umbilical Socket
	RJ45 Socket
	Auxiliary Umbilical Socket
	6- and 16-way Harting Sockets
	CAT5 Cable
	25-core Switchgear Umbilical Cable
	12-core Auxiliary Umbilical Cable
	Auxiliary Umbilical Adapter Box
	RS485 Adapter Box











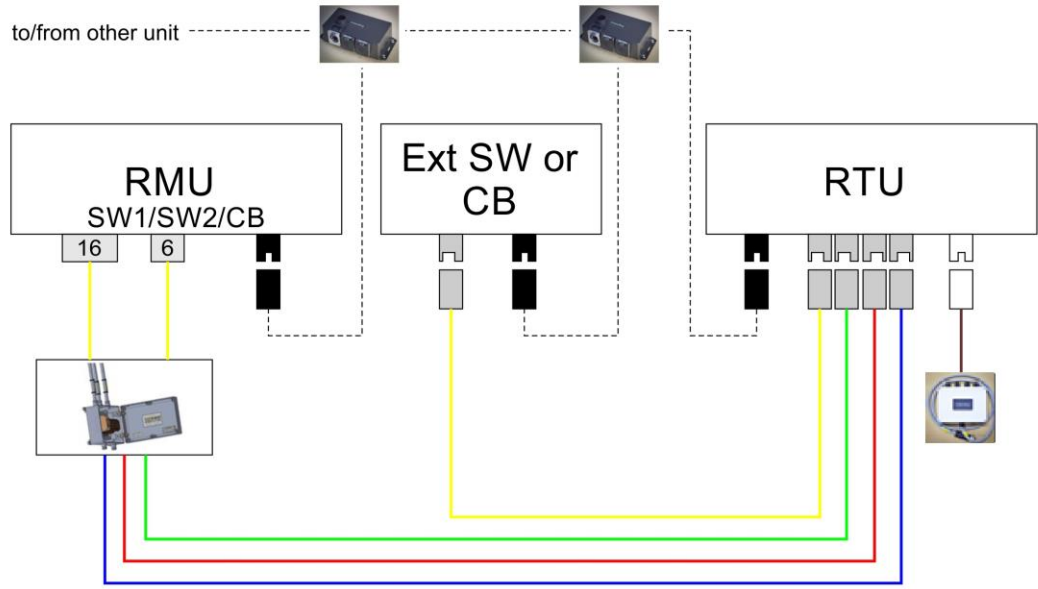







# RTU for Containerized Substations:



# Retrofit RMU Substation Solution:



KEY	
	Umbilical Plug
	RJ45 Plug
	Auxiliary Umbilical Plug
	Umbilical Socket
	RJ45 Socket
	Auxiliary Umbilical Socket
	6- and 16-way Harting Sockets
	CAT5 Cable
	12-core Switchgear Umbilical Cable
	12-core Auxiliary Umbilical Cable
	Auxiliary Umbilical Adapter Box
	RS485 Adapter Box
	Umbilical-to Harting Adapter Box (LPN)



# Panel Switchgear Substation Solution:

4 Switch RTU



Switchgear Umbilicals



Up to 4 off Switchgear Umbilicals

1 off Aux Umbilical



Panel Switchgear



Cables



# Retrofit Actuator Solutions:



Reyrolle ROKKS



Tyke solution



T4GF3 retrofit solution

[www.remsdaq.com](http://www.remsdaq.com)  
Tel: +44 (0)1244 286 495